UNIT 1: CREATING A SWITCHED WIRED ETHERNET LAN

Unit Structure

- 1.0 Learning Objectives**
- 1.1 Introduction to UTP CAT series cables**
- 1.2 RJ-45 connectors**
- 1.3 Color coding scheme**
- 1.4 Crimping a UTP cable to RJ-45 connector**
- 1.5 Physically connecting individual nodes to the switch**
- 1.6 Selection of server machine**
- 1.7 Windows 8.1 Server Installation and Configuration on Server Machine**
- 1.8 Windows 8.1 Desktop installation and configuration on client nodes**
- 1.9 Checking connectivity**
- 1.10 Basic troubleshooting/diagnostic commands**
- 1.11 Let Us Sum Up**
- 1.12 Answers for Check Your Progress**
- 1.13 Glossary**
- 1.14 Assignment**
- 1.15 Activities**
- 1.16 Case Study**
- 1.17 Further Readings**

1.0 Learning Objectives

After learning this unit, you will be able to understand:

- About UTP CAT series cables
- About crimping UTP cable
- About server machine

- About Windows 8.1 Server

1.1 Introduction to UTP CAT series cables

Ethernet cables are grouped in sequence numbered categories supported different specifications; typically the category is updated with further clarification or testing standards. These categories are how we can simply know what type of cable we need for a particular application.

It is noticed that Category 5 cable was revised and upgraded with category 5 enhanced (Cat-5e) cables with similar physical look inside and outside the cable, with required testing standards.

Category 6 was revised with greater than before category 6 (Cat-6a) which shows testing for 500 MHz communication. It is noted that higher communication frequency will eliminate alien crosstalk (AXT) that allow for longer range upto 10 Gb/s.

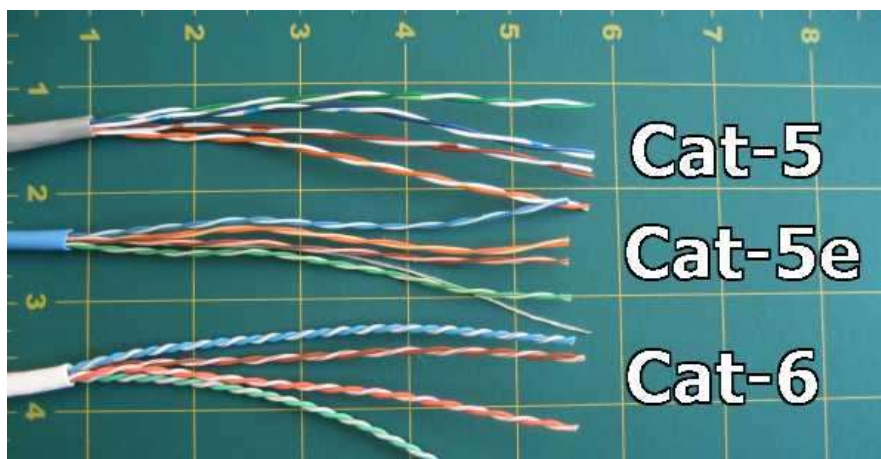

Fig 1.1 Types of CAT cable

It is found that certain Cat-6 cables will carry out nylon spline that will help to remove crosstalk. It is noted that mostly spline is not required in Cat-5 cable. In Cat-6 cable, spline is not required either the cable is long or short and as per standard. Fig 1.1 shows Cat-5e cable with spline.

Generally, Ethernet cables are twisted pair where manufactures uses shielding so as to safeguard from interference, while unshielded twisted pair also applied for cables among computer and wall which uses shielding cable for areas having high interference and running cables outdoors or inside walls.



Fig 1.2 UTP and STP Cable

There are different ways to shield an Ethernet cable, but typically it involves putting a shield around each pair of wire in the cable. This protects the pairs from crosstalk internally. It is found that manufactures protect the cables from foreign identities simply by screening UTP or STP cables.

1.2 RJ-45 connectors

RJ connector is registered jack (RJ) standardized physical network interface that connects telecommunications or data equipment. RJ45 could be a standard type of connector for network cables. RJ45 connectors are most commonly seen with Ethernet cables and networks. It's an eight pins to which the wire strands of a cable interface electrically. Standard RJ-45 pin outs define the arrangement of the individual wires needed when attaching connectors to a cable.

Several other kinds of connectors closely resemble RJ45 and might be easily confused for each other. The RJ-11 connectors used with telephone cables, for example, are only slightly smaller (narrower) than RJ-45 connectors.



Fig 1.3 RJ Connector

It is noted that connectors with required jacks are mostly modular connector which can be 50-pin miniature ribbon connector type. Such types are most common twisted pair connector types which is 8-position, 8-contact (8P8C) modular plug and jack called as RJ45 connector.

Check your progress 1

1. Which of the following connector is used with telephone cable?
 - a. RJ45
 - b. Ethernet
 - c. RJ 11
 - d. None of these

1.3 Color coding scheme

RJ-45 conductor data cable consists of 4 pairs of wires each consists of a solid colored wire and a strip of the same colour. There are two wiring standards for RJ-45 wiring:

- T-568A
- T-568B

There are 4 pairs of wires; 10BaseT/100BaseT Ethernet uses only 2 pairs:

- Orange
- Green

Apart from this, other two colors are:

- Blue
- Brown

This is used for second Ethernet line or for phone connections. The two wiring standards are used to create a cross-over cable:

- T-568A on one end
- T-568B on other end

Straight-through cable:

- T-568B
- T-568A

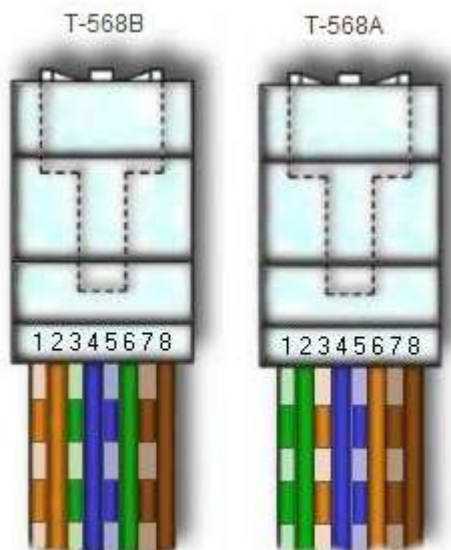

Fig 1.4 Cable T568B and T568A

The RJ45 data cable is used to connect computers to Ethernet switch by straight-through cables. The RJ45 cable uses only 2-pairs of wires:

- Orange (pins 1 & 2)
- Green (pins 3 & 6)
- Pins 4, 5 (Blue) and 7, 8 (Brown) are NOT used

Straight-through cable connects:

- pin 1 to pin 1
- pin 2 to pin 2
- pin 3 to pin 3
- pin 6 to pin 6

Cross-over cables are used to connect:

- TX+ to RX+
- TX- to RX-

That connects pin 1 to pin 3, pin 2 to pin 6, pin 3 to pin 1 and pin 6 to pin 2. The unused pins are generally connected straight-through in both straight-through and cross-over cables.

To network two computers without a hub, a cross-over cable is used. Cross-over cable is also used to connect a router to a computer, or Ethernet switch (hub) to another Ethernet switch without an uplink. Most Ethernet switches today provide an uplink port, which prevents a use of cross-over cable to daisy chain

another Ethernet switch. Straight-through cables are used to connect a computer to an Ethernet switch, or a router to an Ethernet switch.

It is noted that RJ45 cables carries 8 color coded wires, and the plugs have 8 pins and conductors. In this eight wires are used as 4 pairs, each representing positive and negative polarity.

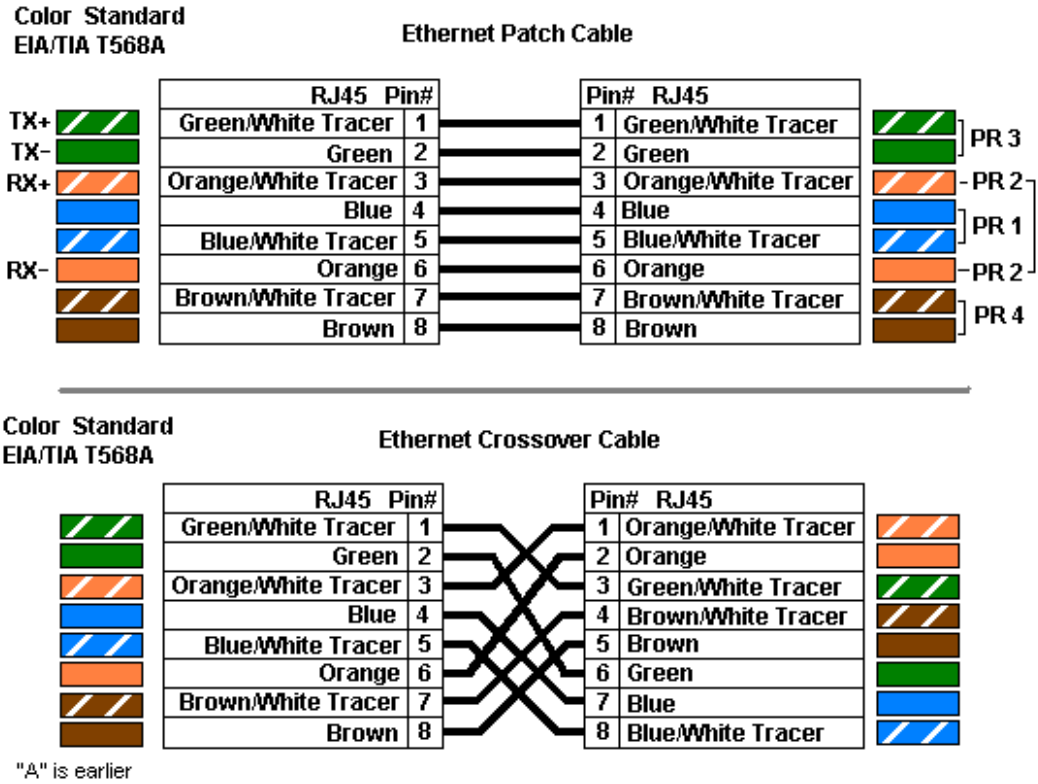

Fig 1.5 Colour Standard of T568A

Color Standard
EIA/TIA T568B

Ethernet Patch Cable



Color Standard
EIA/TIA T568B

Ethernet Crossover Cable

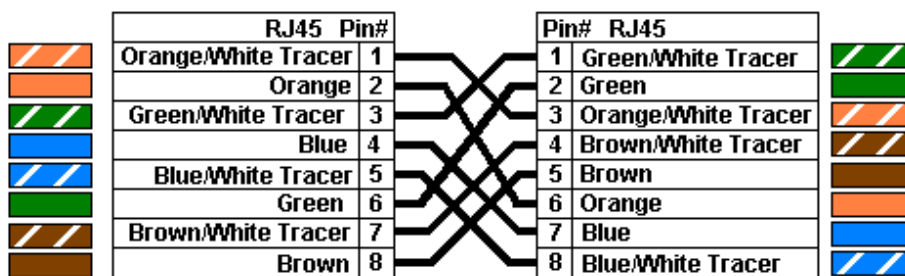

Fig 1.6 Colour Standard of T568B

The most commonly used wiring standard for 100baseT is T-586B standards. Prior to EIA 568A and 568B standards, the color-coded scheme was used to wire RJ45 cables. The table below shows pin and color schemes used in various setup.

Pin	Colored Scheme	T-568B (Common)	T-568A
1	Blue	Orange Stripe	Green Stripe
2	Orange	Orange	Green
3	Black	Green Stripe	Orange Stripe
4	Red	Blue	Blue
5	Green	Blue Stripe	Blue Stripe
6	Yellow	Green	Orange
7	Brown	Brown Stripe	Brown Stripe
8	White (or Grey)	Brown	Brown

Table 1.1 Pin and Colour Scheme of RJ45 Connector

Check your progress 2

1. RJ-45 conductor data cable consists of _____ of wires
 - a. 4 pairs
 - b. 2 pairs
 - c. 3 pairs
 - d. 6 pairs

1.4 Crimping a UTP cable to RJ-45 connector

A UTP cable is one of the most popular LAN cables which consist of 4 twisted pairs of metal wires. Adding RJ45 connectors at both the ends of the UTP cable will allow the cable to work in LAN network system. There are some steps that to be followed to crimp UTP cable into RJ 45 connector:

Step 1: Initially cut the plastic sheath about 1 inch from end of cut cable with the use of razor blade located in crimping tool.

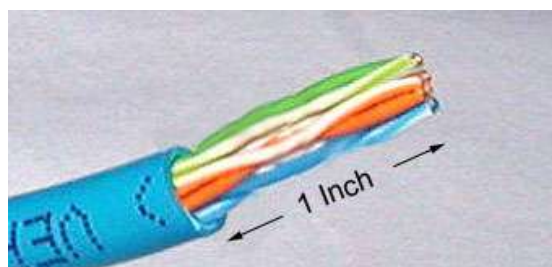

Fig 1.7 Cutting of Cable sheath

Step 2: Now unwind and pair the similar colors as shown in fig.

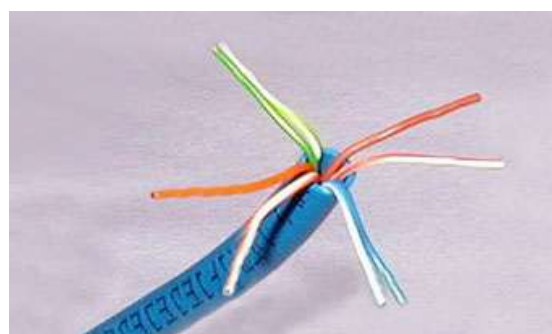

Fig 1.8 Unwind the coloured wires

Step 3: Keep the wires in between the fingers and make the wires straight with required colour orders.

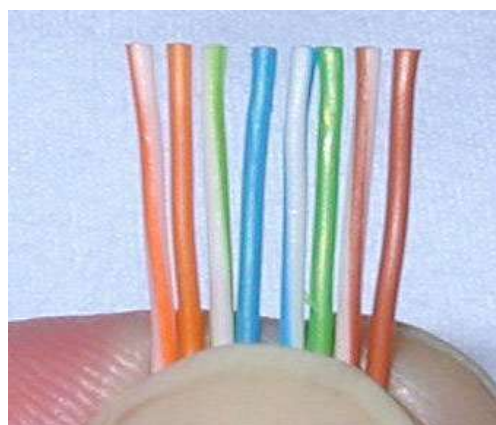

Fig 1.9 Straighten wires with fingers

Step 4: Use scissors to make a straight cut across 8 wires to make them short by 1/2 Inch from cut sleeve to wire end.



Fig 1.10 Scissor

Step 5: Now insert 8 colour wires in RJ 45 connector by considering proper position of blue plastic sleeve.

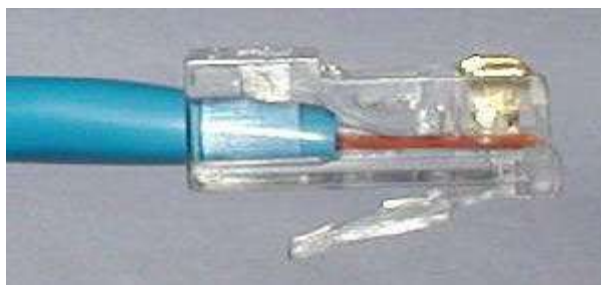

Fig 1.11 Wires in RJ 45 Connector

Step 6: Now crimp the cable carefully by putting RJ 45 connector in Ethernet Crimper and push on handles tightly. You will find that copper splicing tabs on connector will cut into each of eight wires.



Fig 1.12 Crimping of wire

After crimping UTP cable in RJ 45 connector, you find the cable as shown in fig 1.13.

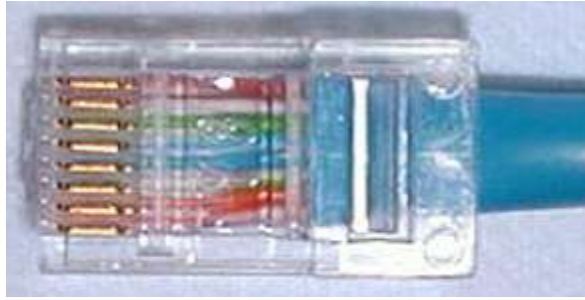

Fig 1.13 Cable in RJ 45 Connector

Check your progress 3

1. Full name of UTP is_____.
 - a. Universal Transport Port
 - b. Unshielded Transport port
 - c. Unshielded Twisted Pair
 - d. None of these

1.5 Physically connecting individual nodes to the switch

Switches are often a valuable asset to networking. Overall, they can increase the capacity and speed of your network. However, switching shouldn't be seen as a cure-all for network problems.

Switches occupy the same place in the network as hubs. Unlike hubs, switches examine each packet and process it accordingly rather than simply repeating the signal to all ports. Switches map the Ethernet addresses of the nodes residing on each network segment then allow only the required traffic to pass through the switch. Once a packet is received by the switch, the switch examines the destination and source hardware addresses and compares them to a table of network segments and addresses.

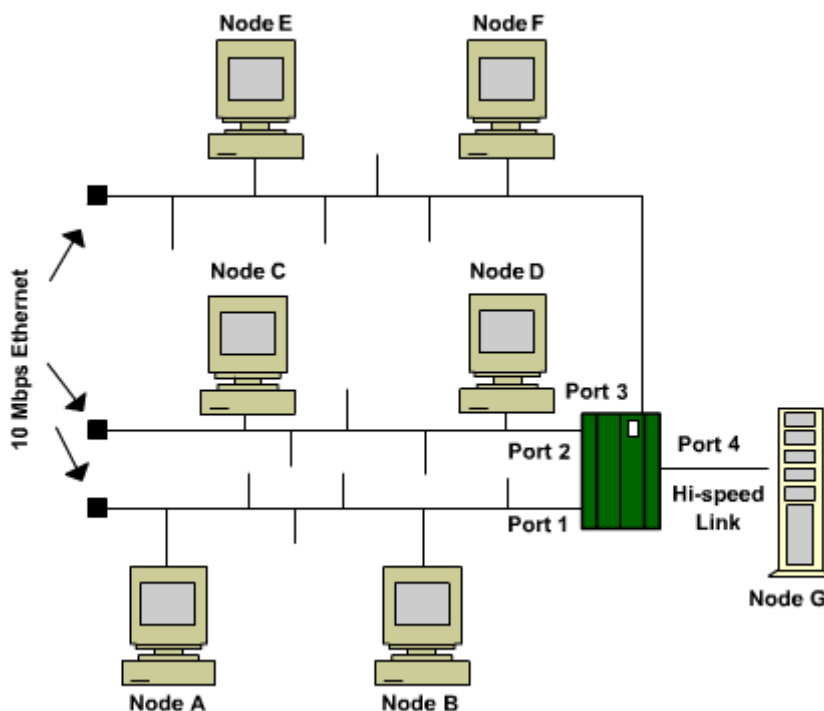

Fig 1.14 Nodes in network

Just like bridge, a switch does more of its job in high-speed hardware by providing performance closer to single-LAN performance than bridged-LAN performance.

Also unlike a bridge, which shares the LAN bandwidth among all of its ports, a switch dedicates the entire LAN media bandwidth, such as 10-Mbps Ethernet, to each port-to-port frame transmission. In this way, a switch easily multiplies the amount of effective network bandwidth.

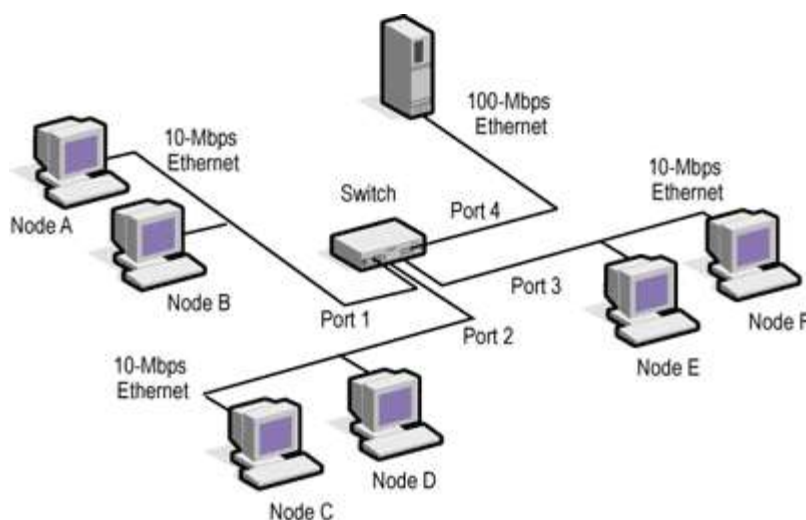

Fig 1.15 Connecting nodes with switches

Check your progress 4

1. Switches operates at_____.

 - a. Network layer
 - b. Data Link layer
 - c. Transport layer
 - d. None of these

1.6 Selection of server machine

It is found that small server look not different from high end desktop computer which is designed for easy operating system which can run certain desktop applications such as:

- word processor
- spreadsheet
- email client
- web browser

A server runs a specialised operating system designed to support several users. It's engineered to run multiuser applications like email, messaging, and print servers; shared calendar programs; databases; and enterprise resource planning and customer relationship management software.

A server additionally makes it easy for your employees to share information and collaborate, since it operates as a central repository for all of your documents, images, contacts, and other necessary files. It can host a company intranet, for sharing information with your employees quickly and economically. Set up a virtual private network, and you and your employees will access the data on the server remotely from anywhere you have internet access. On top of that, a server can automatically back up your desktop and laptop systems; therefore you'll never lose critical data if one machine fails or is lost or stolen. Servers are designed to be reliable, secure, and fault-tolerant, with redundant storage options.

When selecting correct server it is noted that it depends on large measure on applications which you want to work on. In case of file sharing, automated client backup, and light-duty remote access for PCs, we need to think for NAS or Windows Home Server. In a business having more than 10 employees are using

computers, then if you wish to use an email or print server, or you want to handle complex database, or run sophisticated server-based applications, or you have to store large information, or large-scale virtualization, in such cases there are more option such as tower, rack or blade server.

Virtualization enables one server to behave as several servers, each with its own operating system and unique set of applications. A virtual machine consists solely of software, yet it has all the components of a physical machine: it's a motherboard, a CPU, a hard disk, a network controller, and so on. The operating system and other applications run on a virtual machine just as they would on a physical machine--they see no difference between the 2 environments.

In virtualization, a program referred to as a hypervisor places an abstraction layer between the operating systems and therefore the hardware. The hypervisor will operate multiple virtual machines with the same OS or different OSs on the same physical server. Microsoft, Oracle, and VMware are among the top virtual-machine developers.

Check your progress 5

1. A server runs a specialised _____ system designed to support several users.
 - a. Operating
 - b. Hardware
 - c. OS and Software
 - d. None of these

1.7 Windows 8.1 Server Installation and Configuration on Server Machine

Windows 8.1 is an upgraded version of Windows 8 which is also computer operating system by Microsoft. It is part of Windows 8's support lifecycle and on installation maintains access to support. According to Microsoft, the following actions need to be performed before the installation of Windows Server:

Unplug of UPS system: Any power backup system needs to be unplugged or removed before installing Windows Server 8.1.

Back up data: It is highly recommended that you should take complete backup of configuration information for servers which include booting and system partitions.

Running of Windows Memory Diagnostic tool: Such type of testing procedure will tests the capacity and features of computer's RAM.

Use of mass storage drivers: You need to save driver file to appropriate media so that you can provide it during setup.

Default action of Windows Firewall: Server applications that require inbound connections will fail until you create inbound firewall rules that allow these connections.

Prepare your Active Directory environment for Windows Server 2012 R2: Before adding a Windows Server 2012 R2 domain controller or updating an existing domain controller to Windows Server 2012 R2, prepare the domain and forest by running Adprep.exe.

Check your progress 6

1. Why backing up of data is required?
 - a. To save configuration information
 - b. To save System data
 - c. To be secure from data loss in case of system failure
 - d. All of these

1.8 Windows 8.1 Desktop installation and configuration on client nodes

Client deployment refers to the planning, installation, and management of System Center 2012 Configuration Manager Client computers and mobile devices in your enterprise. The types of devices that you have, your business requirements, and your preferences, determine the methods that you use to manage computers and mobile devices.

For installation of Windows 8.1 Desktop version, the table 1.1 shows the required parameters:

Component	Minimum Requirement	Microsoft Recommended
Processor	1.4 GHz	2 GHz or faster
Memory	512 MB RAM	2 GB RAM or greater
Available Disk Space	32 GB	40 GB or greater
Optical Drive	DVD-ROM drive	DVD-ROM drive
Display	Super VGA (800x600) monitor	XGA (1024x768) monitor

Table 1.1 Parameters required for installation of Windows

Check your progress 7

1. What is meant by client deployment?
 - a. delivering software to client
 - b. user testing
 - c. It is the planning, installation, and management of System
 - d. All of these

1.9 Checking connectivity

The next target is to check the connectivity of modem or routers which can be configured initially so as to use the Internet while preventing other services from Internet. If you are not confident of your network whether it has configured or not, in such case you have to contact network administrator. If your network is not configured to block services, but some Internet applications work and others do not, then the issue is probably not related to your Wi-Fi network. There are certain steps you need to follow:

Step 1: Make sure that Wi-Fi device is ON. Computer carry inbuilt card that gets ON when turning it ON for use. When the Wi-Fi interface is ON and connected to Wi-Fi network, then Wi-Fi menu gets bold which is at top right corner of screen.

When the menu becomes dark, in such case your computer gets connected to Wi-Fi network.

Step 2: If Wi-Fi is off, choose Turn Wi-Fi On from the menu.

When you do find menu bar, then in such case select System Preferences from Apple menu and click Network icon and after that select Wi-Fi. Now click on check box located next to Show Wi-Fi status in menu bar as shown:

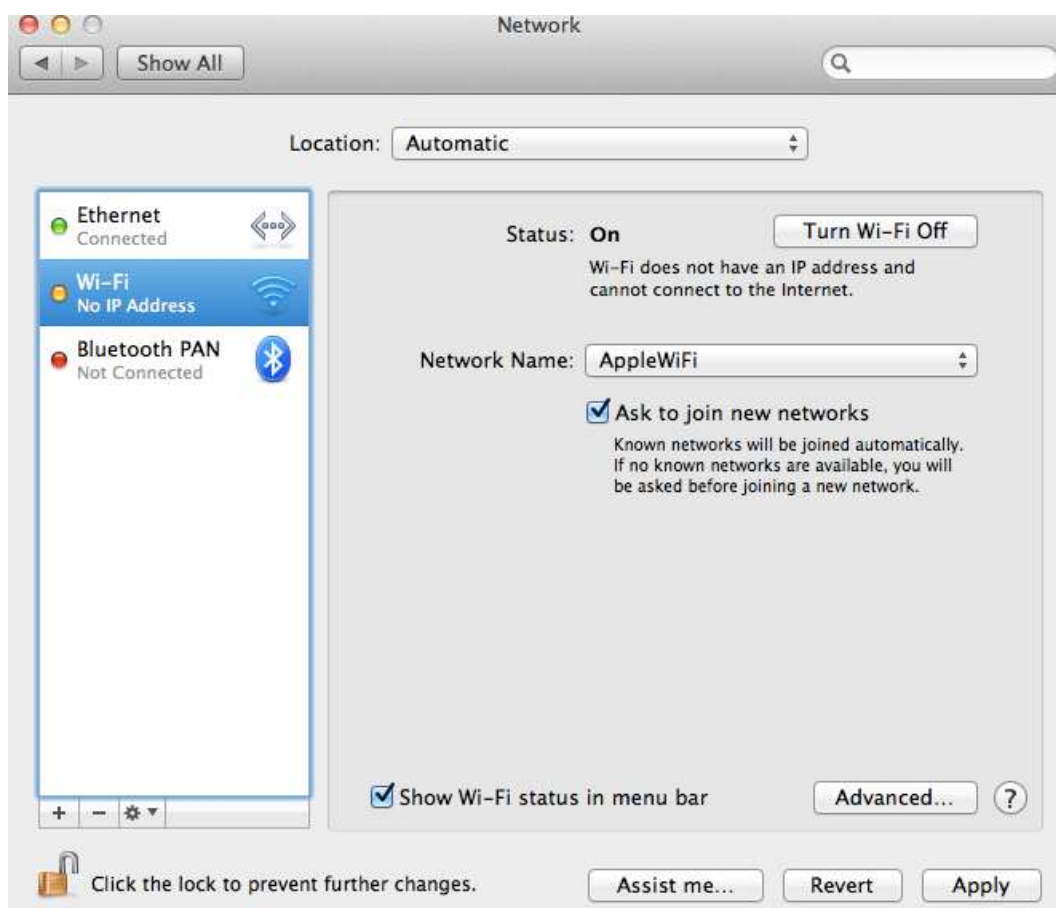

Fig 1.16 Checking connectivity

If your Wi-Fi interface does not appear in System Preferences, then you'll need to make assure that Wi-Fi card gets identified by computer. In such case load using CD or from Recovery HD if OS X Lion is installed. Your computer should be able to access available networks.

Step 3: After all when you are unable to get it online, then in such case make sure that your computer has connected with right Wi-Fi network as per the listing from the Wi-Fi menu as shown in figure:



Fig 1.17 Setting of Wi-Fi

Select your network if it is not chosen. If your Wi-Fi network is secured using a password, you will be prompted to enter a password as shown below.



Fig 1.18 Using Password

In this, you have to insert password. If you do not know your network password, then in such case, you have to contact the administrator of Wi-Fi network. If you are administrator/owner of network, you should configure router to define password for network.

Your Wi-Fi network may not be visible in the list. If the network is closed, it will not broadcast its network name. In order to join the Wi-Fi network, choose Join Other Network from the Wi-Fi menu. You will be prompted for the network name and security setting.



Fig 1.19 Network name

In this, enter the name of network and select Security of your network uses.

When the network is not seen in your Wi-Fi network list, then it means that such network is not applicable. To check the standards, you have use Network Utility, where you should set network interface to Wi-Fi and study about information listed after Model:

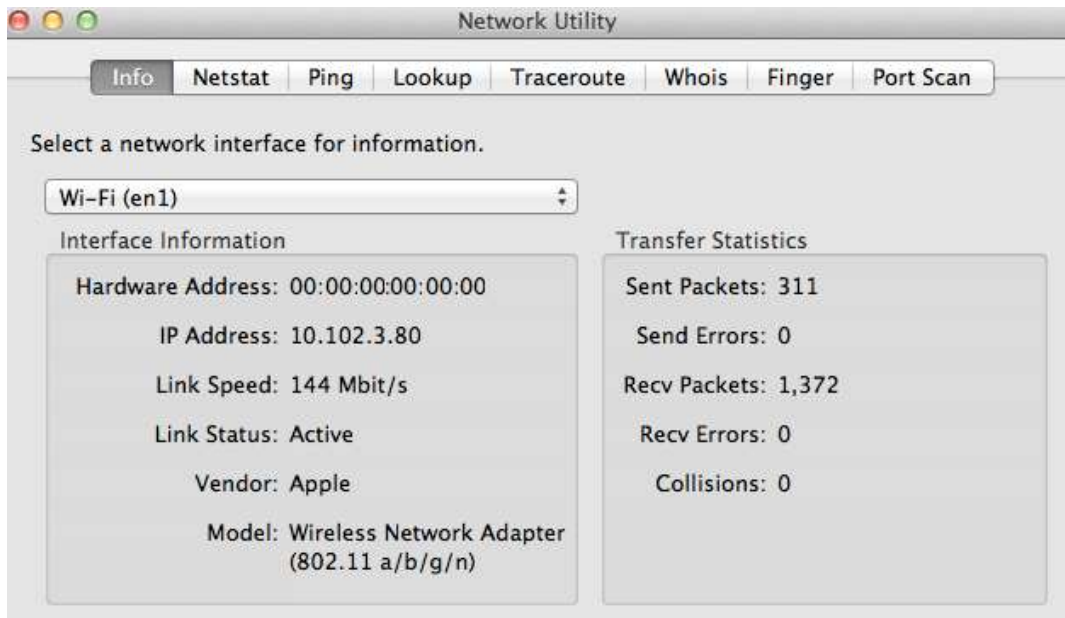

Fig 1.20 Network Utility

In case of correct Wi-Fi network, but still can't find online, then you need to check TCP/IP settings which is available in Network pane of System Preferences.

- Choose System Preferences from the Apple menu.
- Choose Network from the View menu.

- Select Wi-Fi, and then click the advanced button in the lower-left hand corner of the screen.
- Select the TCP/IP tab from the top of the screen.

After doing all setting your window will look like:



Fig 1.20 Network TCP/IP

If you see no IPv4 address, or if IP address starts "169.254.xxx.xxx", in such case you need to click on Renew DHCP Lease. Without the correct TCP/IP settings, your computer will not be able to get online.

If your TCP/IP settings appear to be correct, and your computer still cannot access the Internet, check the DNS tab. See below for this tab. DNS is an Internet service that translates IP addresses into URLs and vice-versa. A correct DNS configuration allows your computer to connect to www.apple.com without having to enter the specific IP address of the Apple servers.

Check your progress 8

1. Network configuration cannot be done:
 - a. using CD
 - b. online
 - c. pen drive
 - d. hard disk

1.10 Basic troubleshooting/diagnostic commands

Local area networks (LAN) are integral to the operation of many businesses today. The most common LANs use Ethernet, a data link layer protocol, and Internet Protocol (IP), a network layer protocol.

Root causes of network troubleshooting problems are frequently caused by one of these three sources:

1. Physical layer: copper, fibres or wireless

Possible causes:

- Damaged or dirty cabling or terminations
- Excessive signal attenuation
- Insufficient cable bandwidth
- Wireless interference

2. Network Layer: Ethernet and IP

Possible causes:

- Damaged networking devices
- Incorrect or sub-optimal device configurations
- Authentication and association issues
- Insufficient network bandwidth

3. Switches and VLANs

Possible causes:

- Excessive utilization
- Too many errors

- Incorrectly assigned VLAN membership
- Traffic priority (CoS/QoS) issues

Check your progress 9

1. What is the cause of trouble at network layer?
 - a. Excessive utilization
 - b. Damaged or dirty cabling or terminations
 - c. Incorrect or sub-optimal device configurations
 - d. Excessive signal attenuation

1.11 Let Us Sum Up

In this unit we have learnt that RJ connector is registered jack standardized physical network interface that connects telecommunications or data equipment. RJ45 could be a standard type of connector for network cables. To network two computers without a hub, a cross-over cable is used. Cross-over cable is also used to connect a router to a computer, or Ethernet switch (hub) to another Ethernet switch without an uplink.

Switches are often a valuable asset to networking. Overall, they can increase the capacity and speed of your network. However, switching shouldn't be seen as a cure-all for network problems. Client deployment refers to the planning, installation, and management of System Center 2012 Configuration Manager Client computers and mobile devices in your enterprise.

1.12 Answers for Check Your Progress

Check your progress 1

Answers: (1 -c)

Check your progress 2

Answers: (1 -a)

Check your progress 3

Answers: (1 –c)

Check your progress 4

Answers: (1 –b)

Check your progress 5

Answers: (1 -a)

Check your progress 6

Answers: (1 –d)

Check your progress 7

Answers: (1 –c)

Check your progress 8

Answers: (1 –b)

Check your progress 9

Answers: (1 –c)

1.13 Glossary

1. **Structured P2P** - where the nodes are arranged having a particular distributed data structure.
2. **Unstructured P2P** - where the nodes have arbitrarily selected other close nodes.
3. **Hybrid P2P** - where some nodes are presented as special functions in a good organized manner.
4. **Workstation-server Model** - Workstation may be a standalone system or a part of a network.
5. **Processor-pool Model** - Provides processing power on a demand basis.
6. **Integrated Hybrid Model** - Workstations used as processor pools.

1.14 Assignment

Try to do Windows 8.1 Server Installation.

1.15 Activities

Crimp a UTP cable into RJ 45 connector.

1.16 Case Study

Study the LAN network of your college.

1.17 Further Readings

1. Distributed Systems, Principles and Paradigms by Tanenbaum.
2. Distributed Systems, Concepts and Design by Coulouris, Dollimore, Kindberg.